

#1 SCREEN (STD)

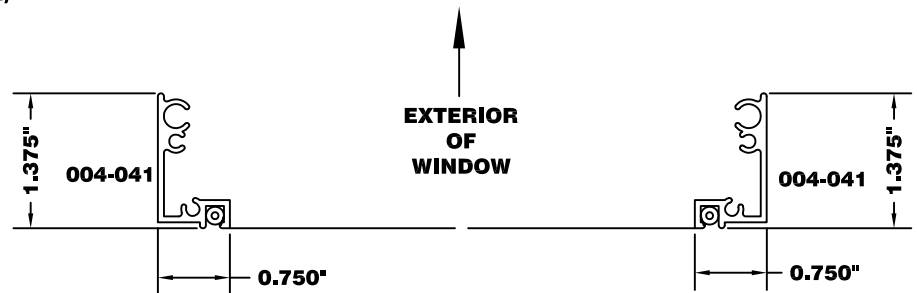

#4 SCREEN

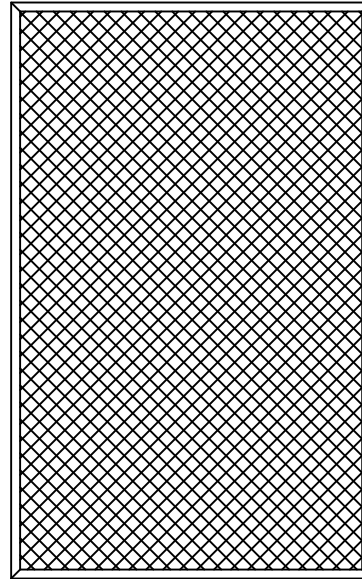
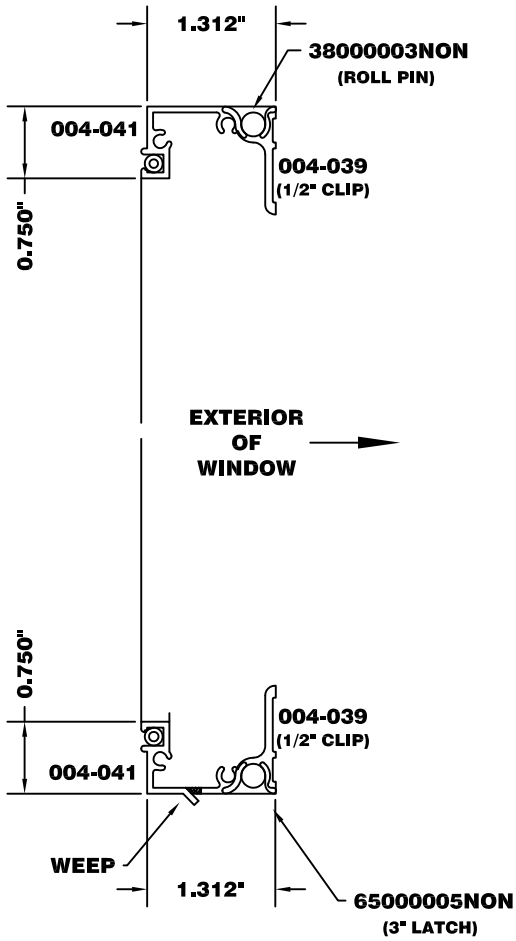
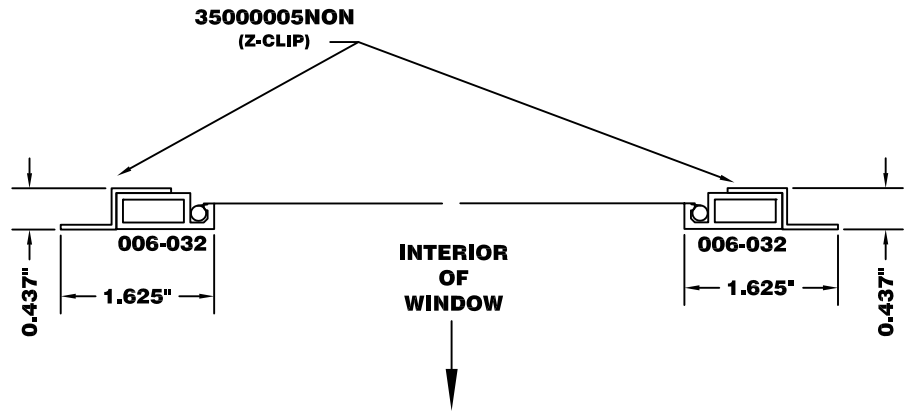
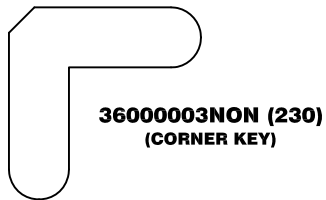
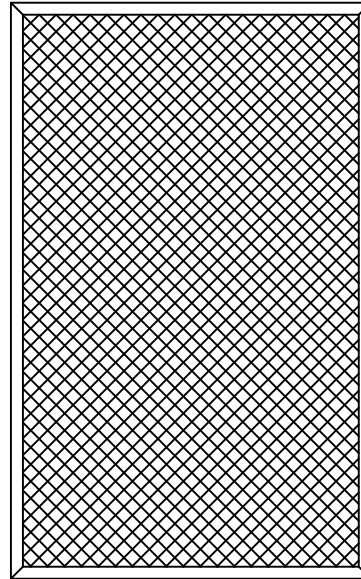
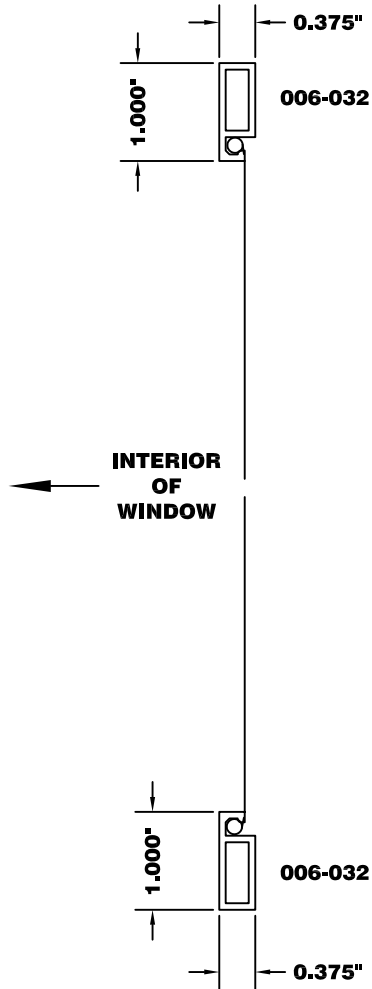

#5 SCREEN

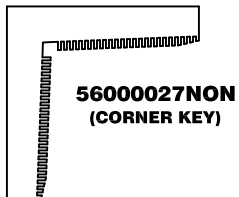
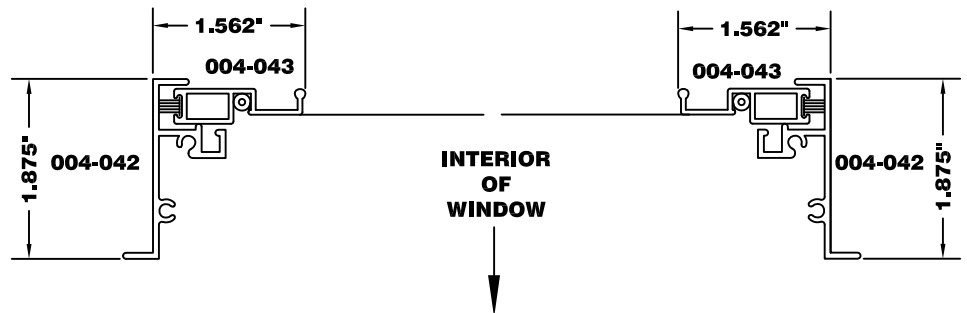
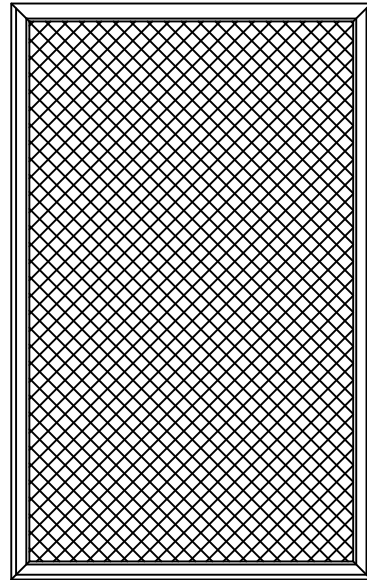
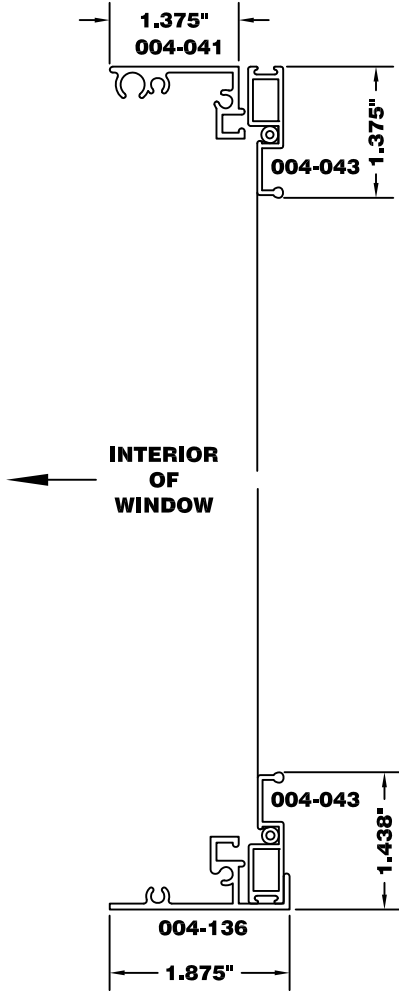

#7 SCREEN (STD)

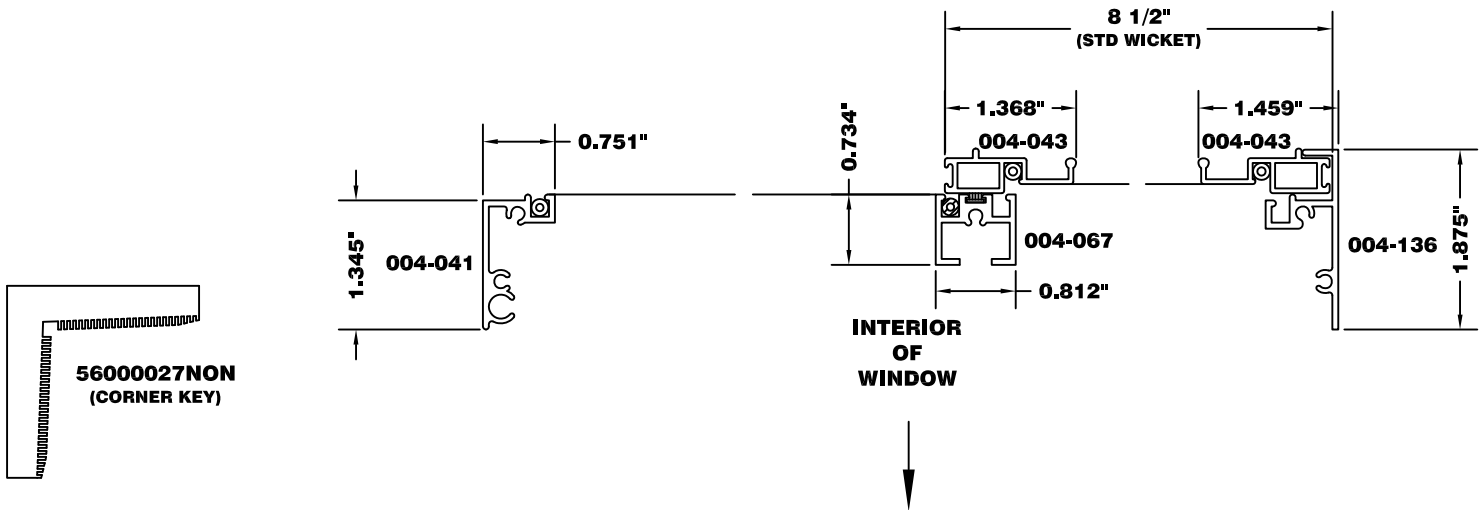
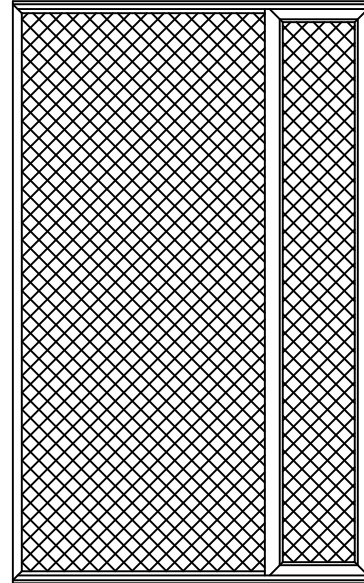
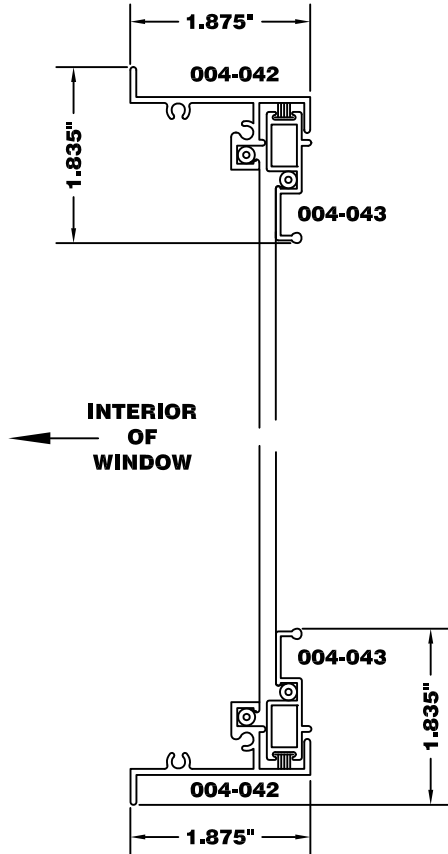

#8 SCREEN

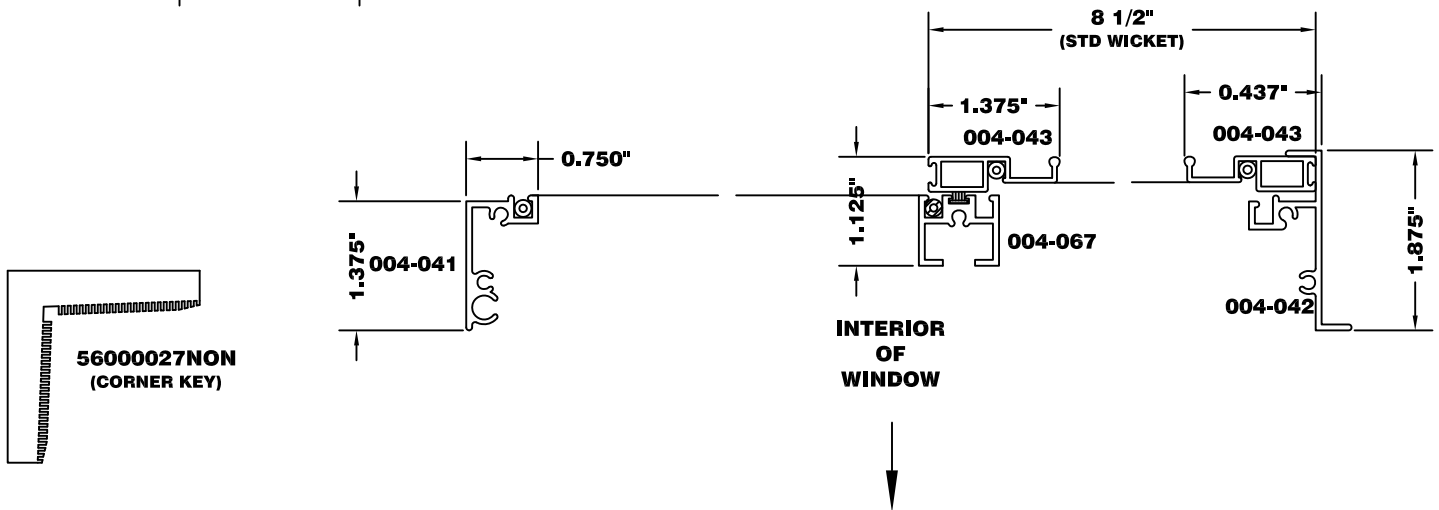
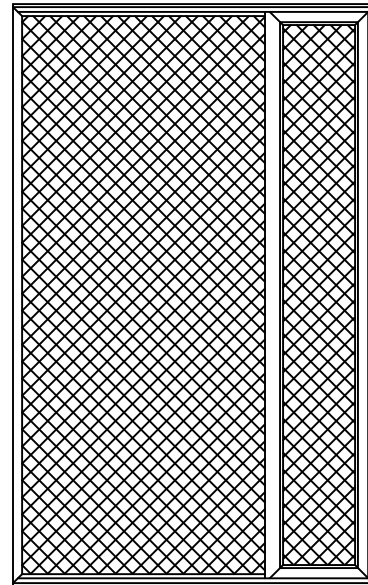

56000027NON
 (CORNER KEY)

#9 SCREEN

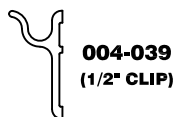
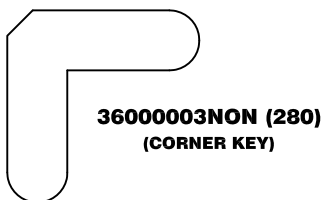
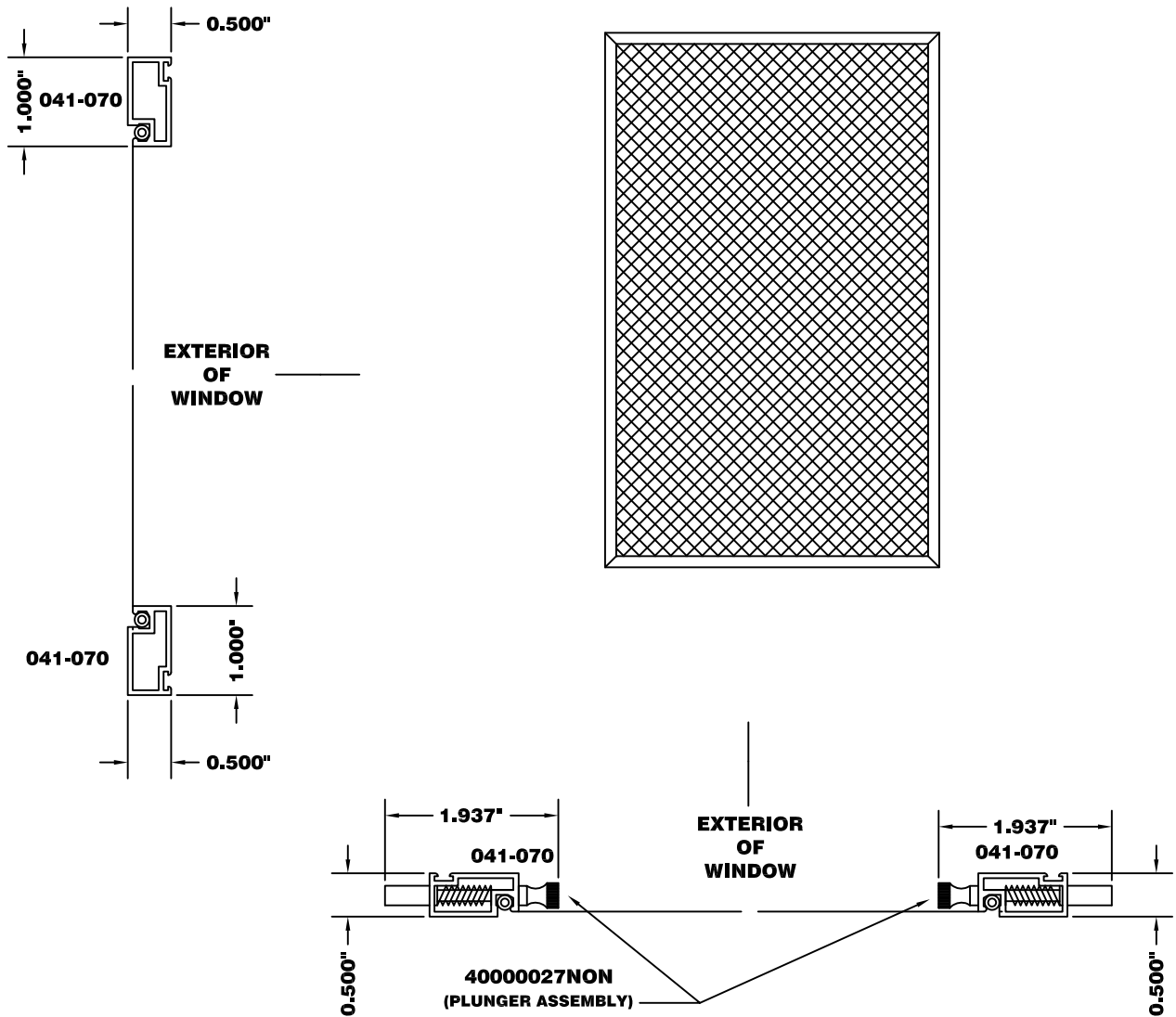

A SCREEN (EGRESS)

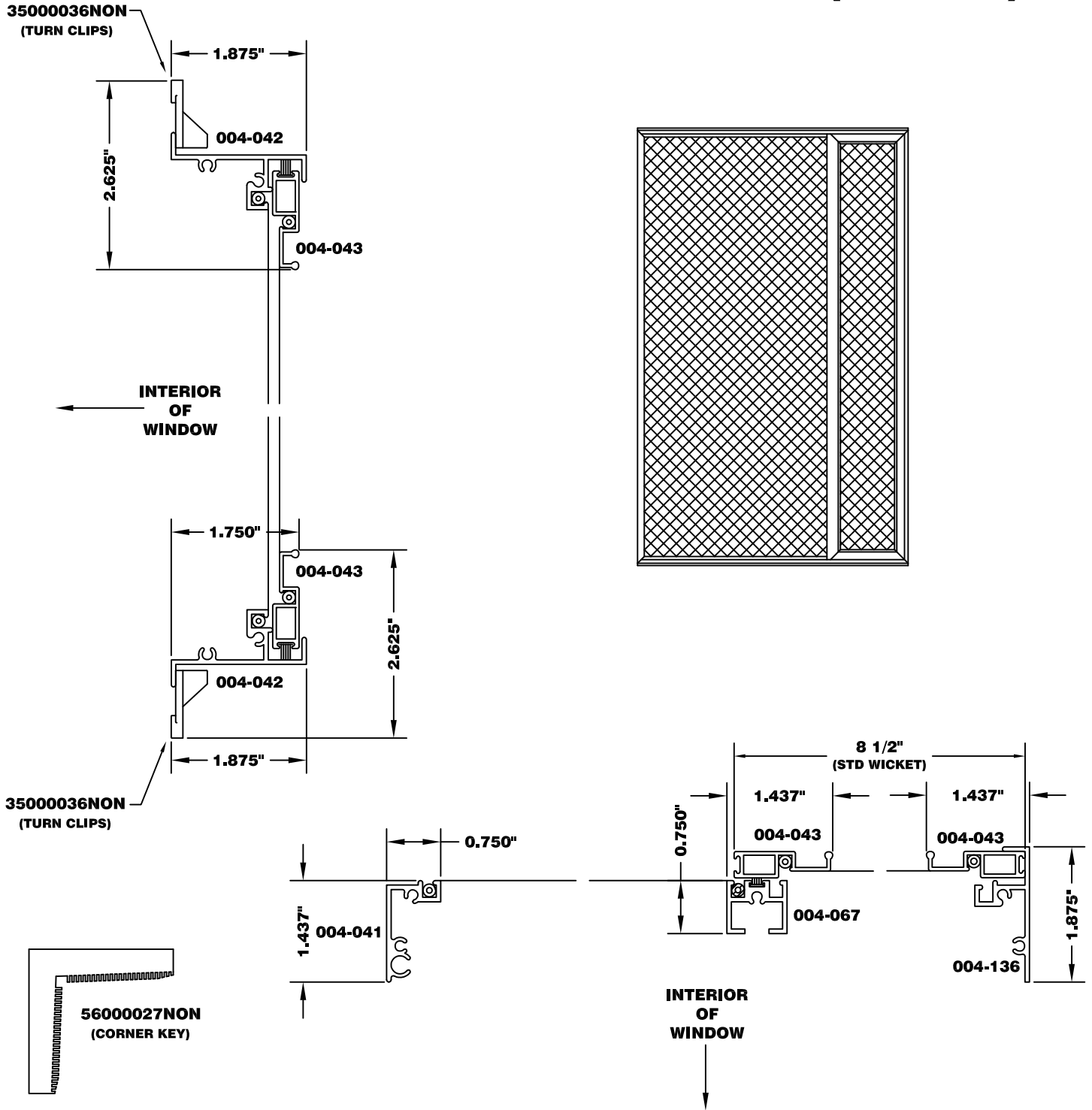

B SCREEN (EGRESS)

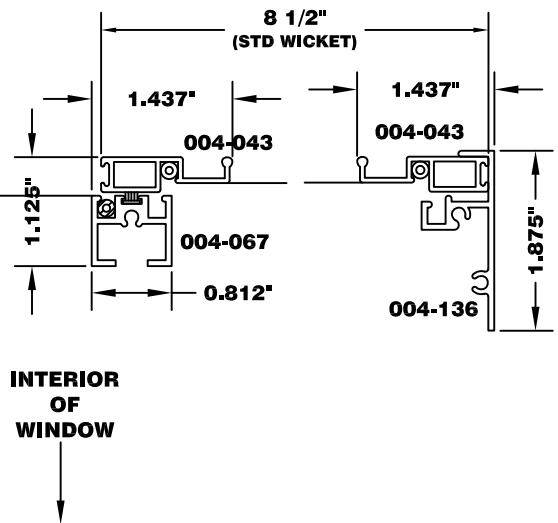
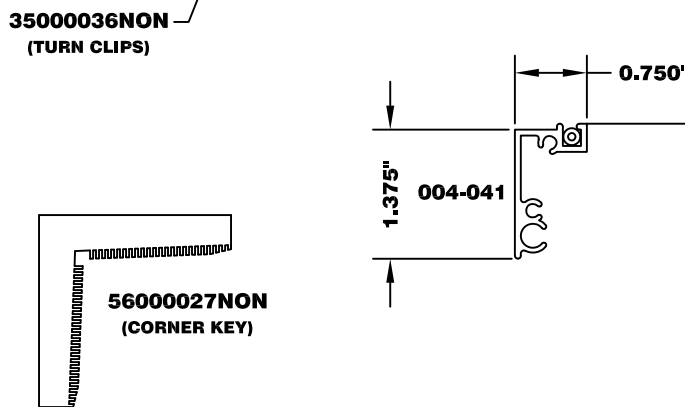
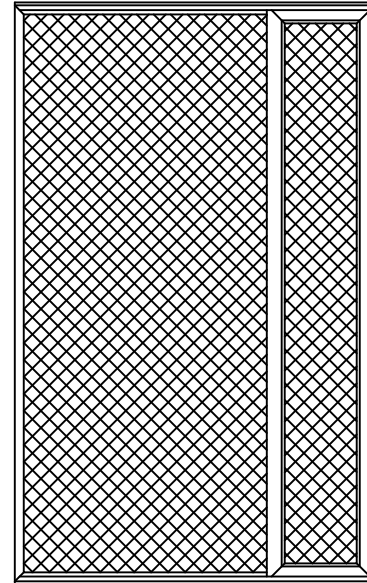
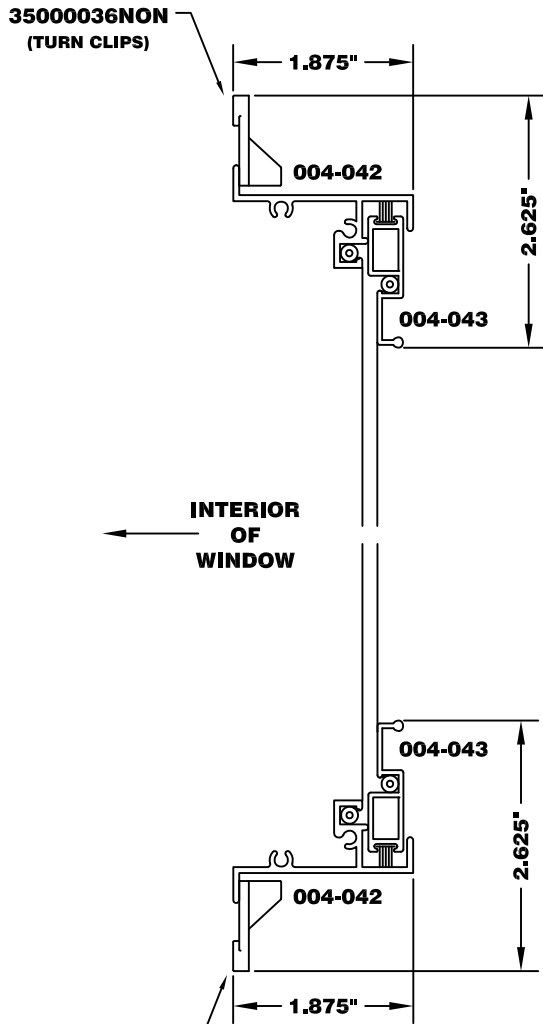

C SCREEN (EGRESS)

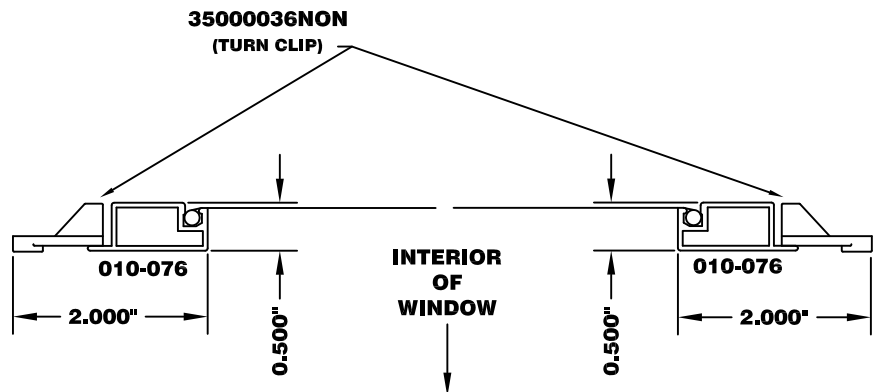
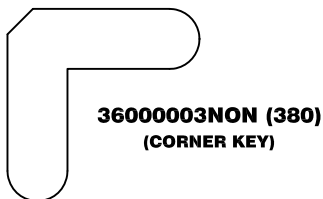
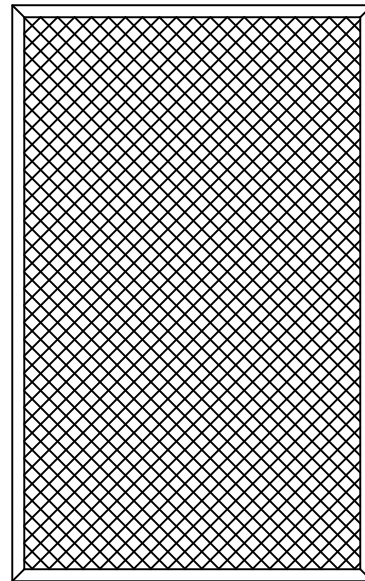
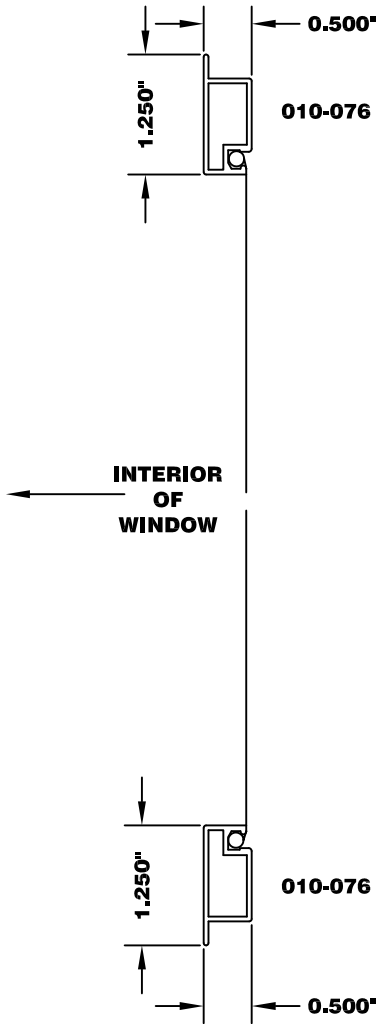

D SCREEN (OVERSIZED VENTS)

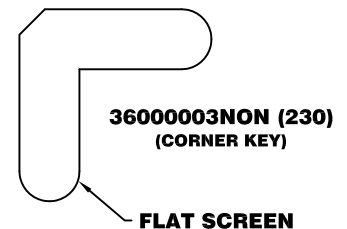
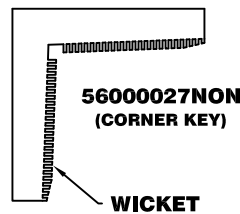
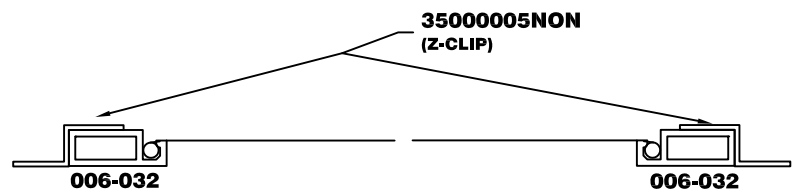
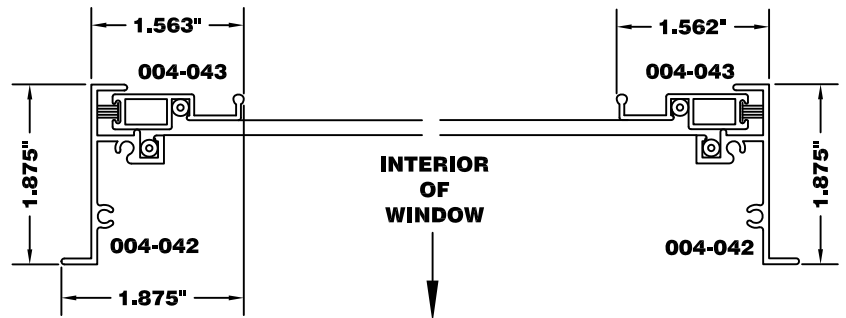
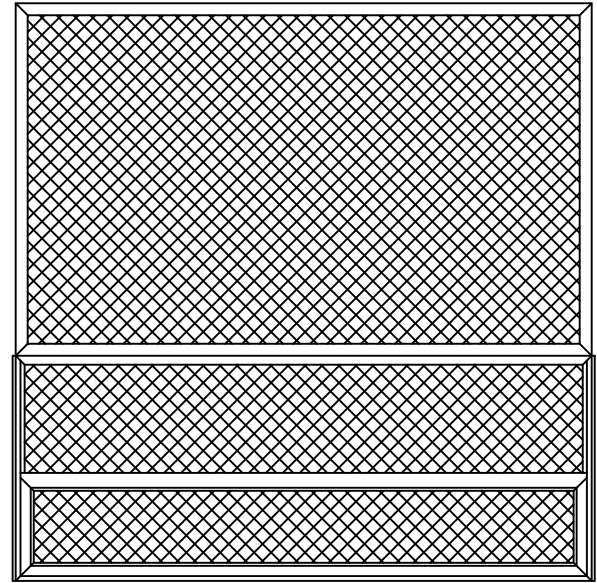
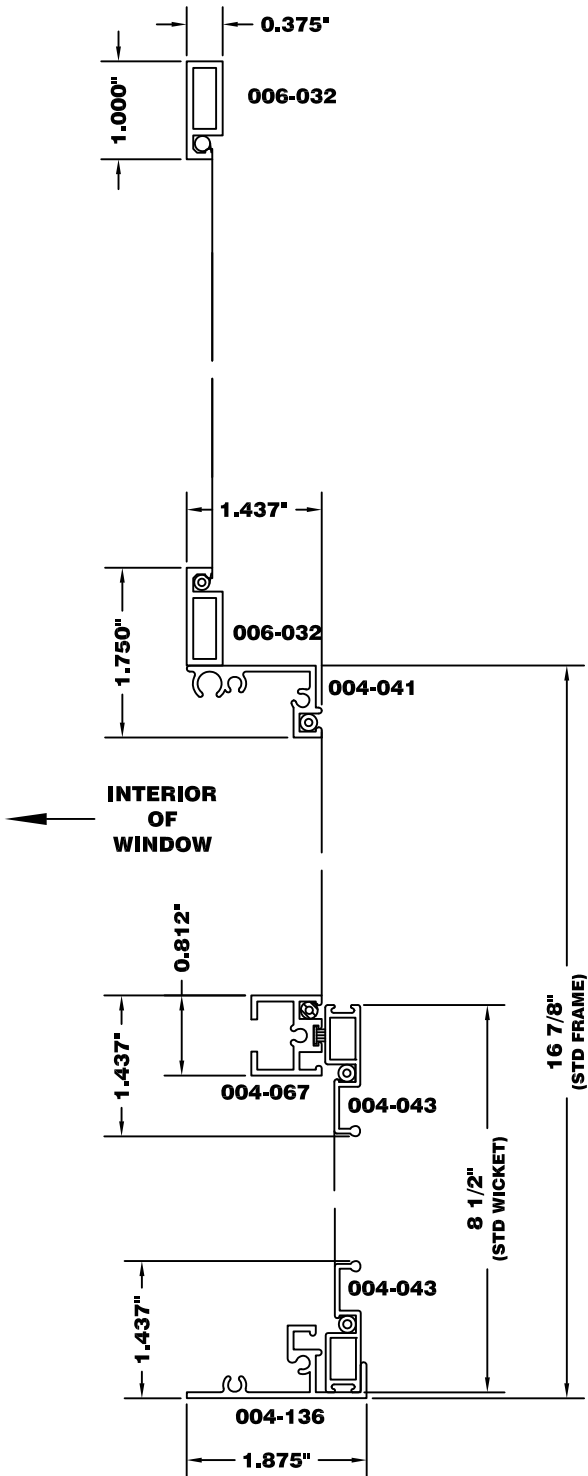

U SCREEN (.014 SS MESH)

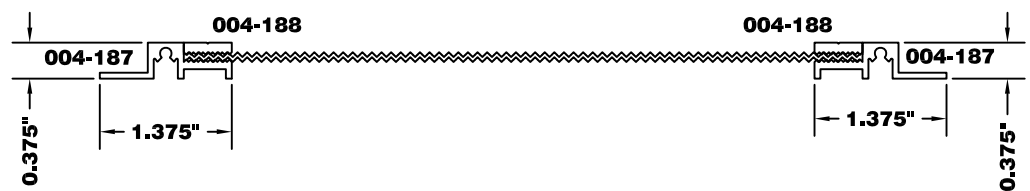
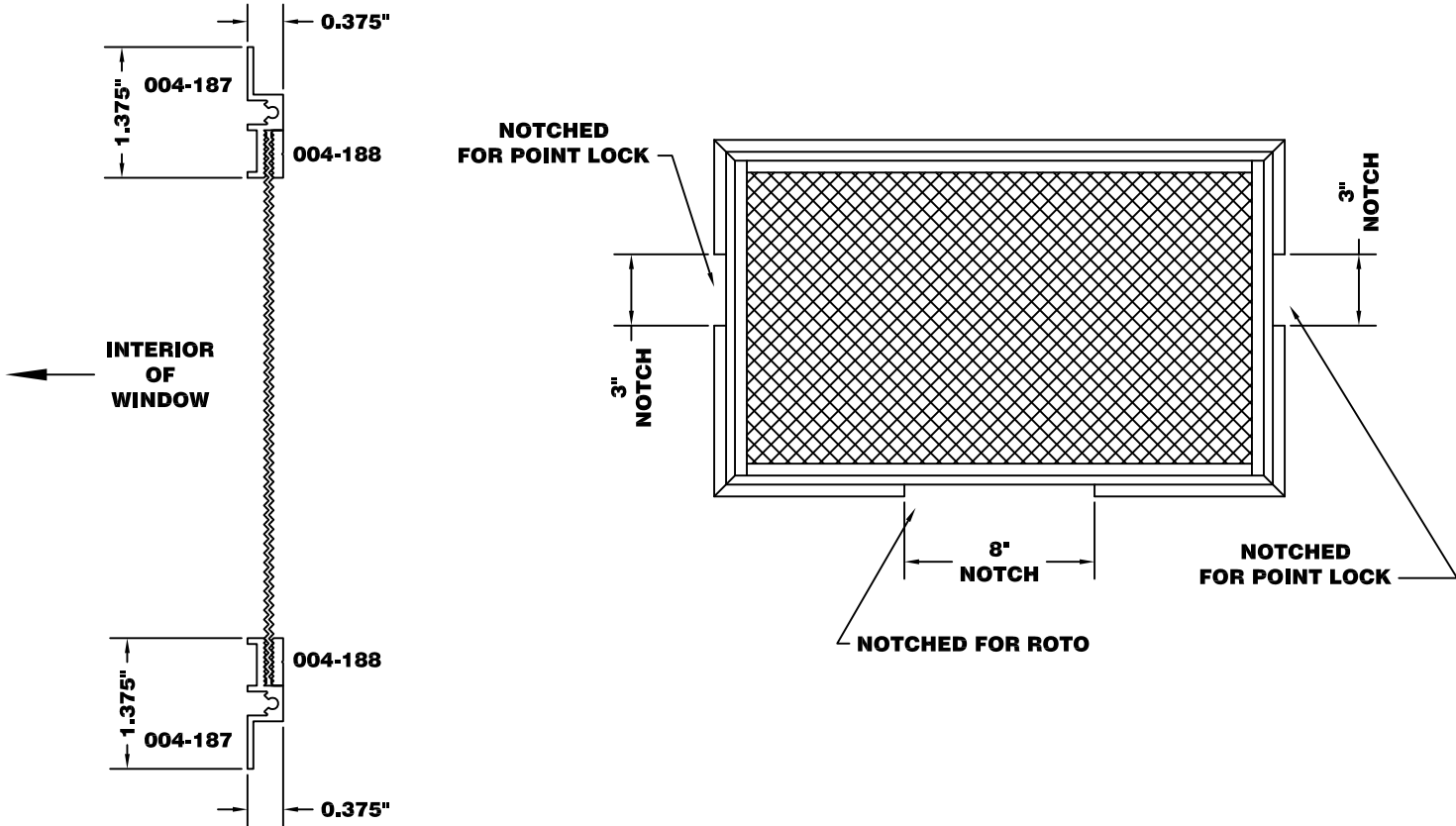

CLETE HEIGHTS RUN FULL